



User's Operation Instructions & Important Warranty Information

High-efficiency wall-hung boilers

Baxi Avanta Plus

18s - 24s - 30s

24c - 28c - 35c - 39c

Dear Customer,

Thank you for purchasing this appliance.

Please read this manual carefully before using the product and keep it in a safe place for future reference.

In order to ensure continued safe and efficient operation we recommend that the product is regularly maintained. Our Service and After Sales organization can assist with this.

We hope you will receive many years of satisfactory service.

A Trading Division of Baxi Heating UK Ltd (3879156)
Brooks House, Coventry Road, Warwick. CV34 4LL
After Sales Service 0844 871 1525
Technical Enquiries 0844 871 1555

Website www.baxi.co.uk

BAXI



Contents

Contents	3
1 Safety	4
1.1 General safety	4
1.2 Safety during operation	4
2 Problems with boiler and/or central Heating system	5
2.1 Error codes – errors which can be resolved by the user	5
2.2 Error codes – errors which have to be remedied by the installer	5
3 Changing boiler settings	6
3.1 Changing P1 setting: flow temperature of water in central heating system	6
3.2 Changing P2 setting: domestic hot water temperature	6
3.3 Changing P3 setting: boiler regulation (domestic hot water and central heating mode)	6
3.4 Changing P4 setting: Eco or comfort mode	7
3.5 Changing P6 setting: display on/off	7
4 Disabling the boiler	8
4.1 Disable boiler with frost protection, during longer periods of non-use	8
4.2 Disable boiler without frost protection, during longer periods of non-use	8
5 Enabling the boiler	9
6 Warranty & Service	10
6.1 Standard Warranty Terms & Conditions	10
6.2 Our promise to you	10
6.3 What you need to do if you experience a problem with your heating system or the operation of the boiler	10
6.4 What the warranty covers	10
6.5 What this warranty does not cover	10



Benchmark places responsibilities on both manufacturers and installers. The purpose is to ensure that customers are provided with the correct equipment for their needs, that it is installed, commissioned and serviced in accordance with the manufacturer's instructions by competent persons and that it meets the requirements of the appropriate Building Regulations. The Benchmark Checklist can be used to demonstrate compliance with Building Regulations and should be provided to the customer for future reference. Installers are required to carry out installation, commissioning and servicing work in accordance with the Benchmark Code of Practice which is available from the Heating and Hotwater Industry Council who manage and promote the Scheme.

Visit www.centralheating.co.uk for more information.

1 Safety

1.1 General safety

The following pictograms are used in this manual to specifically draw certain points to your attention:



Danger of electric shock

Serious personal injury can occur because of risk of electric shocks.



Warning

Possible danger of personal injury or material damage to the regulator, building or environment.



Note

Useful tip or practical advice.



See

Important instruction in carrying out a particular operation.

1.2 Safety during operation



Warning

Can you smell gas? What to do:

- Do not smoke and do not create any flame or sparks.
- Do not use any electric switches.
- Turn off the main gas stop cock.
- Open windows and doors.
- Warn those present and leave the building together.
- Call your gas suppliers / installer once you are outside the building, TRANSCO tel. 0800 111 999.



Warning

Can you smell smoke or flue gases? What to do:

- Switch off the boiler.
- Open windows and doors.
- Warn those present and leave the building together.
- Call your installer once you are outside the building.



Warning

Installation location for the boiler!

- Do not store or use any flammable materials, aggressive substance and/or aerosols near the boiler.
- The installation area must be frost-free.
- The switched spur unit for the boiler must always be accessible.



Warning





Water and pipe temperatures!

- The factory setting for the tap water temperature is 55°C; this temperature can be set to 65°C.
- The maximum water temperature in the boiler can reach 90°C. This means that pipes and/or radiators can reach this temperature.
- If the boiler is running, the flue duct can reach a high temperature.

2 Problems with boiler and/or central Heating system

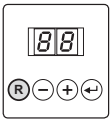
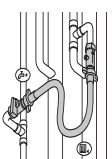
2.1 Error codes – errors which can be resolved by the user

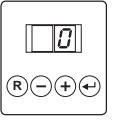
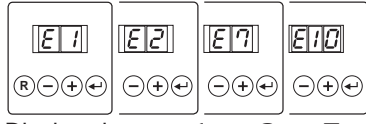
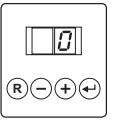
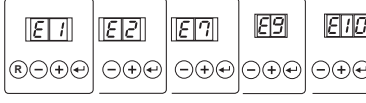
Fig.1 Errors which can be resolved by the user

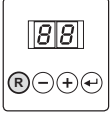
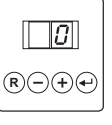
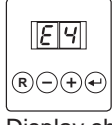
<p>e 1 e 2 e 7 e 9 e 1 O</p>	 <p>Check water pressure: water pressure is greater or equal to 1 bar.</p>	 <p>Press R-key</p>  <p>Top up your central heating system</p>	 <p>Press R-key</p>	<p>Or</p>  <p>Wait for recovery; display shows 0, boiler functions properly.</p> <p>Or</p>  <p>Display shows e 1 , e 2, e 7 or e 1 O again; note down the error code and boiler type and call your installer</p>  <p>Or</p>  <p>Display shows e 1 , e 2, e 7 , e 9 or e 1 O again; note down the error code and boiler type and call your installer</p>
<p>e 4</p>	 <p>Check yellow gas valve, bottom boiler, gas valve must be in line with gas supply pipe, if necessary open gas valve.</p>	 <p>Press R-key</p>	 <p>Wait for recovery; display shows 0, boiler functions properly.</p>	<p>Or</p>  <p>Display shows e 4 again: note down the error code and boiler type and call your installer.</p>

LT.NL.W6H.000.114 + LT.NL.W6H.000.115 + LT.NL.W6H.000.116 + LT.AL.W7H.000.235 + LT.NL.W6H.000.118 + LT.AL.W7H.000.230 + LT.NL.W6H.000.121 + LT.NL.W6H.000.122

2.2 Error codes – errors which have to be remedied by the installer

If the display indicates a different error code from that described above, note down the error code and boiler type and call your installer. Contact your installer also in the event of a water leak.

3 Changing boiler settings

3.1 Changing P1 setting: flow temperature of water in central heating system

Fig.2 Flow temperature

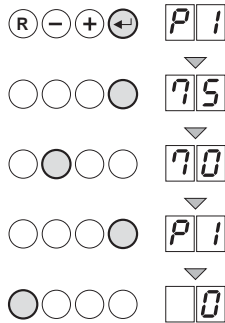

LT.NL.W6H.000.070

Reduce the flow temperature as follows:

- Press **[Enter]**-key until codes p K and K 1 are displayed alternately.
- Press **[Enter]**-key again; set value for maximum flow temperature is displayed: 75°C (factory setting).
- Press **[+]** or **[-]** key to change this value, for example to 70°C.
- Press **[Enter]**-key to confirm value; codes p K and K 1 are displayed alternately.
- Press **[Reset]**-key to switch boiler to operating mode.

3.2 Changing P2 setting: domestic hot water temperature

Fig.3 Domestic hot water temperature

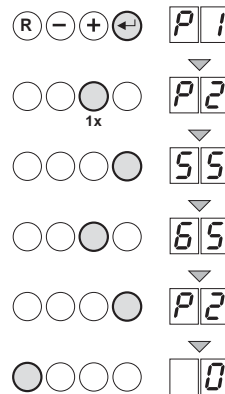

LT.NL.W6H.000.071

Increase the domestic hot water temperature as follows:

- Press **[Enter]**-key until codes p K and K 1 are displayed alternately.
- Press **[+]**-key until codes p K and K 2 are displayed alternately.
- Press **[Enter]**-key ; set value for domestic hot water temperature is displayed: 55°C (= factory setting).
- Press **[+]** or **[-]** key to change this value, for example to 65°C.
- Press **[Enter]**-key to confirm value; codes p K and K 2 are displayed alternately.
- Press **[Reset]**-key to switch boiler to operating mode.

3.3 Changing P3 setting: boiler regulation (domestic hot water and central heating mode)

Fig.4 Boiler regulation

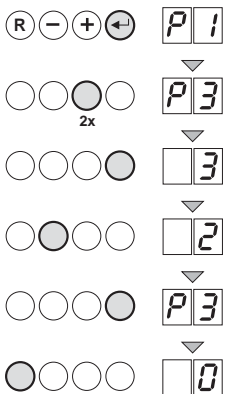

LT.NL.W6H.000.072

- = CH_{off} / DHW_{off}
- 1 = CH_{on} / DHW_{on} (factory setting)
- 2 = CH_{on} / DHW_{off}
- 3 = CH_{off} / DHW_{on}

Change the boiler regulation as follows:

- Press **[Enter]**-key until codes p K and K 1 are displayed alternately.
- Press **[+]**-key 2x until codes p K and K 3 are displayed alternately.
- Press **[Enter]**-key : central heating and domestic hot water mode setting is displayed.
- Press **[+]** or **[-]** key to change this mode, e.g. level 3 (= central heating OFF and domestic hot water ON).
- Press **[Enter]**-key to confirm this mode; codes p K and K 3 are displayed alternately.
- Press **[Reset]**-key to switch boiler to operating mode.

3.4 Changing P4 setting: Eco or comfort mode

Fig.5 Eco or comfort mode

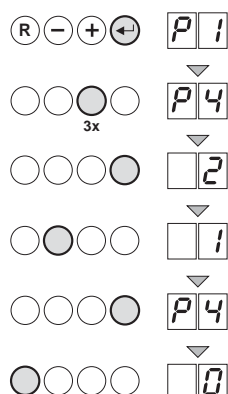

LT.NL.W6H.000.073

i Note - No hot water

Beware; the system boiler in combination with an external calorifier will not warm up the calorifier in the Eco-mode. So, if the calorifier is empty, the tap water will be cold.

- = Comfort mode
- 1 = Eco mode
- 2 = regulated by controller (= factory setting)

Change the mode as follows:

- Press **[Enter]**-key until codes p K and K 1 are displayed alternately.
- Press **[+]**-key 3x until codes p K and K 4 are displayed alternately.
- Press **[Enter]**-key ; setting of 'eco or heat retention' mode is displayed (mode 2 = heat retention and regulator-dependent, factory setting).
- Press **[-]**-key to change this mode, for example mode 1 (=eco mode).
- Press **[Enter]**-key to confirm this mode; codes p K and K 4 are displayed alternately.
- Press **[Reset]**-key to switch boiler to operating mode.

3.5 Changing P6 setting: display on/off

Fig.6 Display on/off

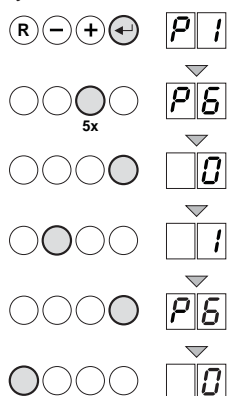

LT.NL.W6H.000.075

Change the display setting as follows:

- Press **[Enter]**-key until codes p K and K 1 are displayed alternately.
- Press **[+]**-key 5x until codes p K and K 6 are displayed alternately.
- Press **[Enter]**-key ; you will see mode 2 (= 'Display automatically off', factory setting).
- Press **[-]**-key to change this mode to mode 1 (= 'Display remains on').
- Press **[Enter]**-key to confirm this mode; codes p K and K 6 are displayed alternately.
- Press **[Reset]**-key to switch boiler to operating mode.

4 Disabling the boiler

The boiler must be disabled before any maintenance or repairs are carried out. If the central heating system is not used for a long time (during the holidays, for instance, or periods of milder weather) it is advisable to disable the boiler.

4.1 Disable boiler with frost protection, during longer periods of non-use

Fig.7 Room thermostat + Switch setting

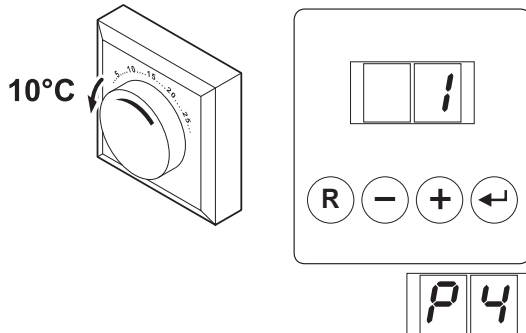

LT.AL.W7H.000.217 + LT.AL.W7H.000.218

- Set the room thermostat to a low temperature, e.g. 10°C,
- Switch setting p 4 to 1 (Eco mode), this will switch off the heat retention function.

Now the boiler will only start working to protect itself against freezing. With an external frost protection connected, the boiler can also prevent the central heating system from freezing.

Pre and After Sales Service

Our dedicated pre-and-after-sales teams are ready to give you the support you need. Its an integral part of the quality package that Baxi offers as standard with all products.

For all your queries please call the Avanta team on: 0844 871 1525

Contact Information

Sales Office: 0844 871 1544
 After Sales Service: 0844 871 1525
 Literature: 0844 335 8821
 Training: 01322 275 604
 Technical Helpline: 0844 871 1525
 Spares Sales Office: 0844 871 1540

4.2 Disable boiler without frost protection, during longer periods of non-use

Fig.8 Switch off

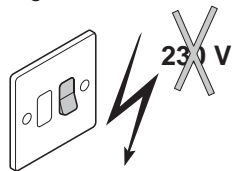

LT.AL.W7H.000.224

- Switch off the boiler.

Fig.9 Turn off gas



LT.AL.W7H.000.228

- Turn off the boiler gas tap.



Warning - Drain boiler

Drain the boiler and central heating system if you will not be using the home for a long period and there is a chance of night frost.

5 Enabling the boiler

Fig.10 Water pressure

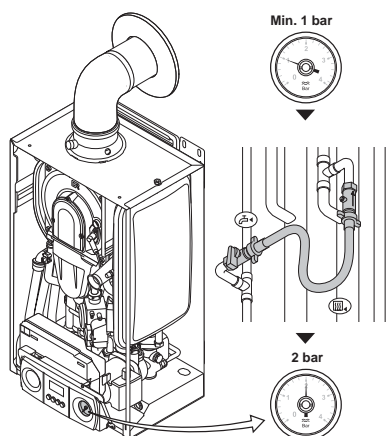

LT.AL.W7H.000.054

Fig.11 Switch on

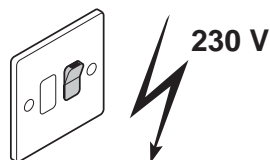

LT.AL.W7H.000.225

Fig.12 Room thermostat

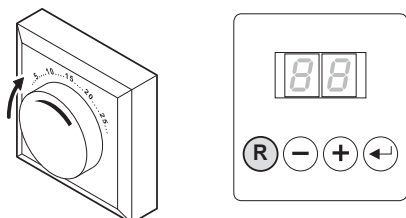

LT.AL.W7H.000.212 + LT.NL.W6H.000.079

- Check the boiler water pressure. If the water pressure is less than 1 bar, the system has to be topped up with water.

- Switch on the boiler at the fused spur unit; the boiler will run the start-up program.
 - A display test will briefly appear showing all segments of the display.
 - f K x x software version;
 - p K x x parameter version;
 - A venting cycle of 3 minutes now follows, the version numbers will be displayed alternately;
 - Next, the following will appear in the display;
 - K 1 pre-purge stage
 - K 2 ignition stage
 - K 3 operating in CH mode or:
 - K 4 operating in DHW mode
 - K 7 pump run on after CH or DHW is satisfied
 - K 0 stand-by mode
- Set the room thermostat to the desired room temperature. The boiler will now automatically start operating.

6 Warranty & Service

6.1 Standard Warranty Terms & Conditions

To activate your warranty you must register your boiler with heateam the service division of Baxi Heating UK Ltd either by completing and returning the registration card or calling our telephone registration line on 0844 871 1525.

It is also a requirement of the warranty that the boiler has an annual service (every 12 months) in accordance with the installation and servicing instructions, performed by a Gas Safe registered engineer. If you would like heateam to carry this out please call on 0844 871 1525 or visit www.heateam.co.uk

6.2 Our promise to you

If you experience a fault with your new boiler, we aim to provide a safe and high quality repair service supported by our dedicated national network of highly skilled engineers. If your installer can't resolve the problem for you, we will do everything we can to get an engineer out to you as quickly as possible. Nothing in this warranty will affect your statutory consumer rights.

6.3 What you need to do if you experience a problem with your heating system or the operation of the boiler.

You should always contact your installer first, because the cause of the fault may not be related to the boiler. If your installer confirms that the fault is with the boiler and he / she can't repair it, our friendly customer service team is on hand to help. Simply call our service division heateam on 0844 871 1525 to book an engineer visit or for any general advice that you may need. Our contact centre is open Monday to Friday 8am - 6pm, weekends and bank Holidays 8:30am - 2pm, excluding Christmas Day and New Years Day.

When calling heateam it would be helpful if you could have the following information to hand:-

1. Boiler serial number
2. Boiler make and model number
3. Your installer name and address details
4. Proof of purchase (if you do not have the boiler serial number)

6.4 What the warranty covers

- Free of charge repair or replacement of components found to be of faulty manufacture.
- Free of charge replacement of the complete unit provided always that the failure is related to a manufacturing fault that cannot be repaired or is uneconomic to repair.

6.5 What this warranty does not cover

- Repairs to boilers which haven't been installed and commissioned properly, and as set out in the installation instructions (this includes the need to flush the system effectively and add a suitable corrosion inhibitor).
- Any damage caused by hard water scale deposits and/or aggressive water resulting from corrosion.
- Any other defects or failures, either in the connected heating system or outside of the boiler itself.
- Faults caused by inadequate supply of electricity, gas or water to the property.
- Installations within commercial settings for which this boiler was not designed.

- Reimbursements of any third party repair or replacement costs that e haven't been told about or agreed with you in advance.
- Compensation for consequential losses (e.g. loss of earnings, business losses, stress and inconvenience) arising from a production breakdown, including repair delays caused by factors outside our reasonable control.

After Sales Service 0844 871 1525

- 90451 Avanta Plus 18s - System
- 90280 Avanta Plus 24s - System
- 90452 Avanta Plus 30s - System
- 90453 Avanta Plus 24c - Combi
- 90282 Avanta Plus 28c - Combi
- 90297 Avanta Plus 35c - Combi
- 90283 Avanta Plus 39c - Combi

Please ensure that the installer has fully completed the Benchmark Checklist on the inside back pages of the installation instructions supplied with the product and that you have signed it to say that you have received a full and clear explanation of its operation. The installer is legally required to complete a commissioning checklist as a means of complying with the appropriate Building Regulations (England and Wales).

All installations must be notified to Local Area Building Control either directly or through a Competent Persons Scheme. A Building Regulations Compliance Certificate will then be issued to the customer who should, on receipt, write the Notification Number on the Benchmark Checklist.

This product should be serviced regularly to optimise its safety, efficiency and performance. The service engineer should complete the relevant Service Record on the Benchmark Checklist after each service.

The Benchmark Checklist may be required in the event of any warranty work and as supporting documentation relating to home improvements in the optional documents section of the Home Information Pack.



Baxi is a licensed member of the Benchmark Scheme which aims to improve the standards of installation and commissioning of domestic heating and hot water systems in the UK and to encourage regular servicing to optimise safety, efficiency and performance.

Benchmark is managed and promoted by the Heating and Hotwater Industry Council.

For more information visit www.centralheating.co.uk

© Copyright

All technical and technological information contained in these technical instructions, as well as any drawings and technical descriptions supplied, remain our property and shall not be multiplied without our prior consent in writing. Subject to alterations

BAXI
A Trading Division of Baxi Heating UK Ltd (3879156)
Brooks House, Coventry Road, Warwick. CV34 4LL
After Sales Service 0844 871 1525 Technical Enquiries 0844 871 1555

Website www.baxi.co.uk

CE

BAXI

PART OF BDR THERMEA

